

Button Cap Stapler

Operating Instructions

Instrucciones de Operacion

Mode d'Emploi

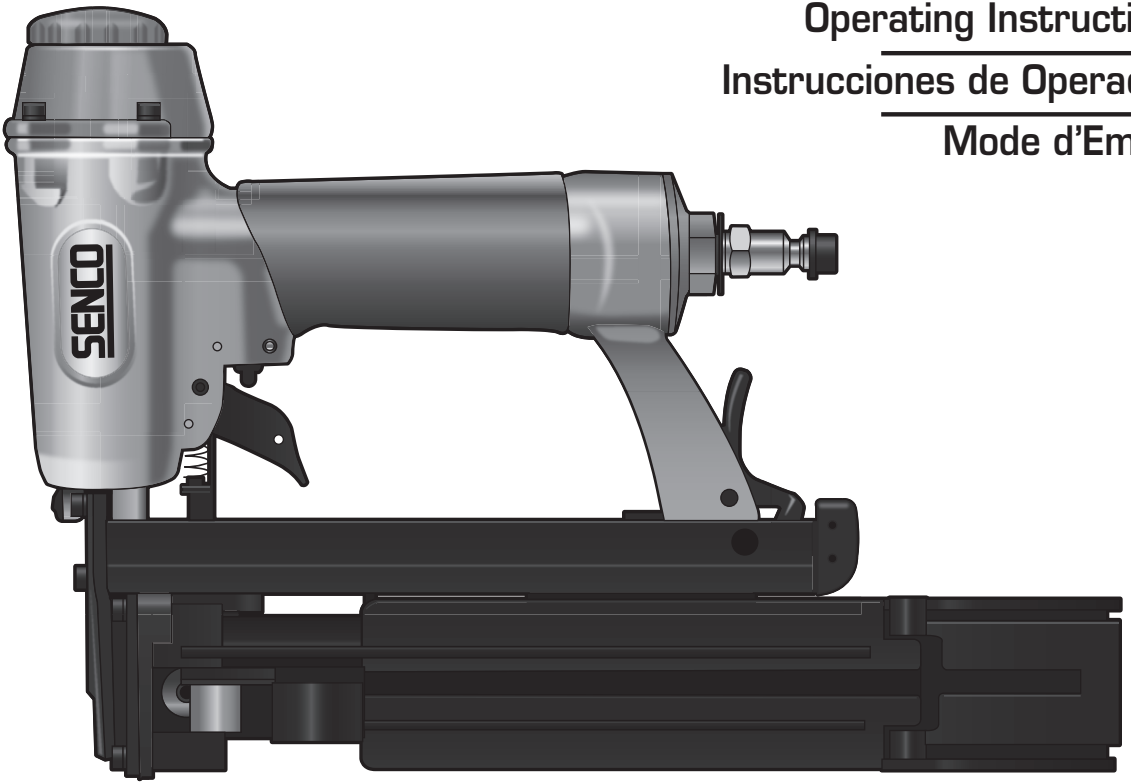

SENCO®

Senco Brands, Inc.
4270 Ivy Pointe Blvd.
Cincinnati, OH 45245
1-800-543-4596
www.senco.com





Warnings for the safe use of this tool are included in this manual.
Los avisos para el uso seguro de esta herramienta están incluidos en este manual.
Les consignes pour l'utilisation en toute sécurité de cet outil se trouvent dans ce manuel.

NFD84A Jan. 2, 2014, replaces Jun. 20, 2012

English	Español	Français			
TABLE OF CONTENTS	TABLA DE MATERIAS	TABLE DES MATIÈRES			
Maintenance	3	Mantenimiento	3	Entretien	3
Tool Use	4	Uso de la Herramienta	4	Utilisation de l'outil	4
Specifications	6	Especificaciones	6	Spécifications	6

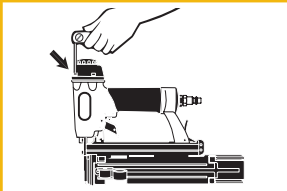
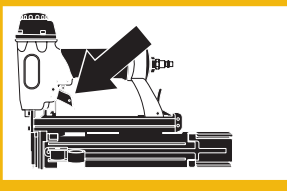
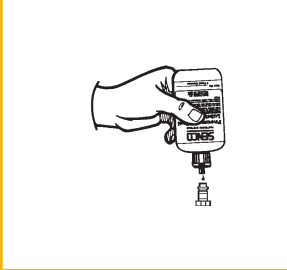
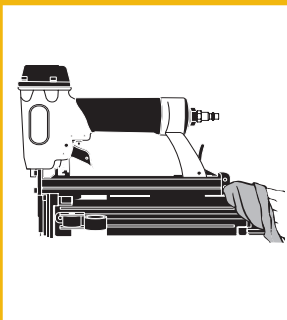
EMPLOYER'S RESPONSIBILITIES	RESPONSABILIDADES DEL EMPLEADOR	RESPONSABILITÉS DE L'EMPLOYEUR
Employer must enforce compliance with the safety warnings and all other instructions which accompany this tool as shipped from the manufacturer.	El empleador debe hacer cumplir las advertencias de seguridad y todas las otras instrucciones que acompañan a esta herramienta como se la despacha desde el fabricante.	L'employeur doit faire appliquer les consignes de sécurité et toutes les autres instructions qui accompagnent cet outil tel qu'il est livré par son constructeur.
Keep this manual available for use by all people assigned to the use of this tool.	Mantenga este manual disponible para que lo usen todas las personas destinadas a hacer uso de esta herramienta.	Ayez ce manuel à la disposition de toutes les personnes chargées d'utiliser cet outil.
For personal safety and proper operation of this tool, read and understand all of these instructions carefully.	Por razones de seguridad personal y la adecuada operación de esta herramienta, lea y comprenda todas estas instrucciones cuidadosamente.	Pour assurer la sécurité personnelle et le bon emploi de cet outil, lisez et assimilez soigneusement toutes ces instructions.

	Maintenance	Mantenimiento	Entretien
	English	Español	Français
	<ul style="list-style-type: none"> Read and understand “SAFETY INSTRUCTIONS” manual shipped with this tool before using tool. 	<ul style="list-style-type: none"> Antes de usar la herramienta lea y comprenda el manual “INSTRUCCIONES DE SEGURIDAD” despachado con ella. 	<ul style="list-style-type: none"> Lisez et assimilez le manuel “Instructions de sécurité” livré avec cet outil avant de l'utiliser.
	<ul style="list-style-type: none"> All screws should be kept tight. Loose screws result in unsafe operation and parts breakage. 	<ul style="list-style-type: none"> Todos los tornillos tienen que mantenerse apretados. Los tornillos sueltos pueden producir una operación poco segura y la rotura de piezas. 	<ul style="list-style-type: none"> Toutes les vis doivent être maintenues serrées à fond. Les vis desserrées entraînent un manque de sûreté du fonctionnement et la rupture de pièces.
	<ul style="list-style-type: none"> With tool disconnected, make daily inspection to assure free movement of trigger. Do not use tool if trigger sticks or binds. 	<ul style="list-style-type: none"> Con la herramienta desconectada, haga inspecciones diarias para asegurar el movimiento libre del gatillo. No use la herramienta si el gatillo se pega o se atasca. 	<ul style="list-style-type: none"> L'outil étant déconnecté de l'arrivée d'air comprimé, effectuez une inspection journalière pour assurer le libre mouvement de la détente. N'utilisez pas l'outil si la détente colle ou se coince.
	<ul style="list-style-type: none"> Squirt SENCO pneumatic oil (5 to 10 drops) into the air inlet twice daily (depending on frequency of tool use). Other oils may damage O-rings and other tool parts. 	<ul style="list-style-type: none"> Aplicar aceite neumático SENCO en la entrada de aire dos veces al día (dependiendo de la frecuencia de uso, 5 a 10 gotas). Otros aceites pueden dañar las juntas tóricas y otras piezas de la herramienta. 	<ul style="list-style-type: none"> Avec une burette, placer 5 à 10 gouttes d'huile pneumatique SENCO dans l'arrivée d'air deux fois par jour (dépend de l'intensité de l'utilisation de l'appareil). D'autres huiles pourraient endommager les joints toriques et d'autres pièces de l'outil.
	<ul style="list-style-type: none"> Wipe tool clean daily and inspect for wear. Use non-flammable cleaning solutions only if necessary—DO NOT SOAK. Caution: Such solutions may damage O-rings and other tool parts. 	<ul style="list-style-type: none"> Use soluciones de limpieza inflamables solamente si es necesario—NO LA REMOJE. Precaución: Tales soluciones pueden dañar las juntas tóricas y otras piezas de la herramienta. 	<ul style="list-style-type: none"> Nettoyez l'outil chaque jour à l'aide d'un chiffon et inspectez-le pour déceler une éventuelle usure. Utilisez uniquement des solvants non inflammables en cas de nécessité—NE LE FAITES PAS TREMPER ! Attention : De tels produits peuvent endommager les joints et autres pièces de l'appareil.
	<ul style="list-style-type: none"> Keep tool pointed away from yourself and others and connect air to tool. 	<ul style="list-style-type: none"> Mantenga la herramienta apuntando en la dirección opuesta a su cuerpo y a otras personas y conecte el aire a la herramienta. 	<ul style="list-style-type: none"> Maintenez l'outil pointé à l'écart d'autres personnes et de vous-même et raccordez l'air à l'outil.

Tool Use

Uso de la Herramienta

Utilisation de l'Outil

English

Español

Français

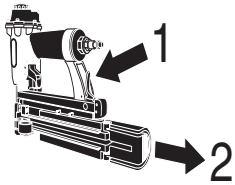

- To load staples:
Depress latch and slide rail open.

- Para cargar:
Oprima el cerrojo y deslice el carril abriéndolo.

- Pour charger :
Appuyer sur le verrou et ouvrir le rail en le tirant.

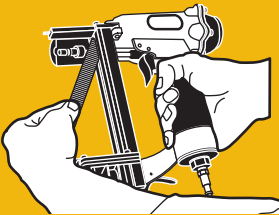

- Lay strip of staples into magazine. Use only genuine SENCO staples. Do not load with trigger depressed.

- Coloque la tira de grapas dentro del cargador. Use solamente grapas SENCO auténticos. No cargue con el gatillo oprimido.

- Insérer la bande d'agrafes dans le magasin. Utilisez uniquement les véritables agrafes SENCO. Veillez à ne pas appuyer sur la détente quand vous chargez.

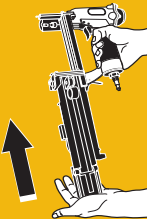

- Push rail forward until it latches.

- Empuje el carril hacia adelante hasta cerrarlo.

- Pousser le rail jusqu'encliquetage.

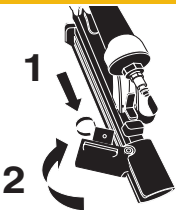

- To load caps:
Pull feeder shoe back completely, opening magazine door to left.

- Para cargar las tapas:
Jale la zapata alimentadora hasta atrás, abriendo la puerta del cargador hacia la izquierda.

- Pour charger les capuchons:
Ramenez complètement le sabot de chargement, en ouvrant la porte du magasin sur la gauche.

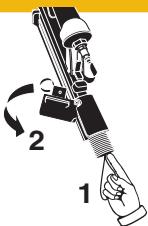

- Insert caps with string extending out back side of magazine. Once caps are in, hold in place, and remove string by pulling. Close magazine door.

- Inserte las tapas con el cordel extendido hacia fuera por el lado posterior del cargador. Una vez que las tapas están adentro, sujételas en su lugar y jale el cordel para sacarlo. Cierre la puerta del cargador.

- Insérez les capuchons avec le ressort dépassant du côté arrière du magasin. Une fois les capuchons entrés, maintenez-les en place et enlevez le ressort en tirant. Refermez la porte du magasin.

Tool Use

Uso de la Herramienta

Utilisation de l'Outil

English

Español

Français

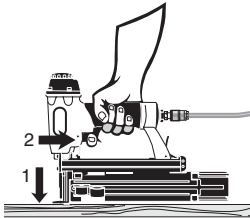

- With a "Dual-Action" trigger, nails can be driven two ways:

a) Position safety element against work surface and pull trigger... "Trigger Fire."

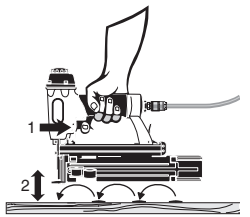

b) To drive a nail, pull trigger and push safety element against work surface. Each time the safety element is pushed against the work surface a nail will be driven. This "bottom-fire" mode of operation is preferred when high production, rapid fastener placement is desired.

- Las herramientas con gatillo de acción doble pueden ser disparadas de dos maneras:

a) Oprima el seguro contra la superficie de trabajo y apriete el gatillo... Disparo de gatillo.

b) Para disparar un clavo, oprima el gatillo y empuje el elemento de seguridad contra la superficie de trabajo. Cada vez que empuje el elemento de seguridad contra la superficie de trabajo, disparará un clavo. Este modo de operación de "disparo inferior" o "por rebote" es el preferido cuando se desea alta productividad y rápida colocación del clavo.

- Les appareils équipés de déclenchement "au toucher / par gâchette" peuvent être utilisés de 2 façons différentes:

a) Déclenchement par "gâchette." Appliquer le palpeur de sécurité de l'appareil à l'endroit désiré et activer la gâchette.

b) Pour planter un clou, tirez sur la détente et poussez l'élément de sécurité contre la surface de travail. Chaque fois que l'élément de sécurité est poussé contre la surface de travail un clou est planté. Le mode de fonctionnement en "tir continu" est préférable si vous désirez placer des attaches rapidement avec forte productivité.

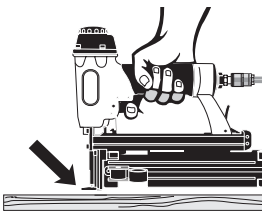

- Fire tool once to advance/load first cap.

- Dispare la herramienta una vez para avanzar/cargar la primera tapa.

- Actionnez l'outil une fois pour faire avancer/charger le premier capuchon.

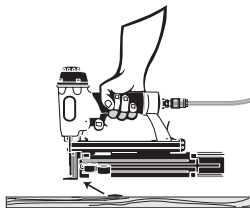

- Lift tool completely from work surface between shots to feed next cap.

- Levante completamente la herramienta de la superficie de trabajo entre cada disparo para hacer avanzar la próxima tapa.

- Soulevez complètement l'outil de la surface de travail entre les déclenchements afin d'alimenter avec le capuchon suivant.

English TECHNICAL SPECIFICATIONS	BC58 4A0001N	
Minimum to maximum operating pressure	80–100 psi	5.5–7 bar
Air Consumption (60 cycles per minute)	.77 scfm	21.8 liter
Air Inlet	¼ in. NPT	¼ in. NPT
Maximum Speed (cycles per minute)	7	7
Weight	4.1 lbs.	2 kg
Staple Capacity	110	110
Tool size: Height	8.5 in.	216 mm
Tool size: Length	12.5 in.	317 mm
Tool size: Width: Main Body	3.5 in.	89 mm

Español ESPECIFICACIONES TECNICAS	BC58	
Presión de operación mínima y máxima	5,5–7 bar	
Consumo de aire (60 ciclos por minuto)	21,8 liter	
Entrada de aire	¼ in. NPT	
Velocidad máxima (ciclos por segundo)	7	
Peso	2 kg	
Capacidad de grapas por cargador	110	
Tamaño de la herramienta: Altura	216 mm	
Tamaño de la herramienta: Longitud	317 mm	
Tamaño de la herramienta: Ancho (Cuerpo)	89 mm	

Français SPÉCIFICATIONS TECHNIQUES	BC58	
Pression de travail min. et max.	5,5–7 bar	
Consommation d'air (60 cycles par minute)	21,8 liter	
Admission d'air	¼ in. NPT	
Vitesse maximum (cycles par seconde)	7	
Poids	2 kg	
Capacité de projectiles par magasin	110	
Dimensions de l'outil: hauteur	216 mm	
Dimensions de l'outil: longueur	317 mm	
Dimensions de l'outil: largeur: corps de l'appareil)	89 mm	

Specifications	Especificaciones	Spécifications
English	Español	Français

M004092

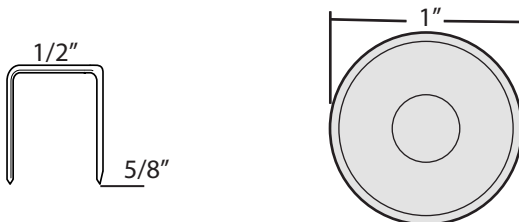

Gauge: 21
 Crown: 1/2" (13 mm)
 Length: 5/8" (16 mm)
 Cap: 1" (25 mm)

Limited Warranty
SENCO® Pneumatic, DuraSpin®, Cordless Tools
& Compressors

Senco Products, Inc. ("SENCO") designs and constructs its products using the highest standards of material and workmanship. SENCO warrants to the original retail purchaser that the following products will be free from defects in material or workmanship for the warranty period specified below:

Pneumatic tools (both XP and Pro) Five Years	Fusion Tools Two Years	Combo Kit Tools One Year	GasTools Two Years
Duraspin Tools One Year	Air Compressors One Year	Multi-Blow Hand Nailers & Stapling Hammers One Year	

During the warranty period (which begins on the purchase date), SENCO will repair or replace, at SENCO's option and expense, any product or part that is defective in materials or workmanship after examination by a SENCO Authorized Warranty Service Center, subject to the exceptions, exclusions and limitations described below. Any replacement product or part will carry a warranty for the balance of the warranty period applicable to the replaced product or part. A DATED SALES RECEIPT OR PROOF OF PURCHASE FROM THE ORIGINAL RETAIL PURCHASER IS REQUIRED TO MAKE A WARRANTY CLAIM. Warranty registration also is required and can be accomplished through on-line Product Registration at www.senco.com or by completing and returning the postage paid warranty registration form included with your Operator's manual/parts chart information, found inside the product carton. To make a warranty claim, you must return the product, with proper receipt/proof of purchase and return transportation charges prepaid, to a SENCO Authorized Warranty Service Center. A list of SENCO Authorized Warranty Service Centers can be found at www.senco.com or by calling 1-800-543-4596 toll free. SENCO will perform its obligations under this warranty, within a reasonable time after approval of the warranty claim.

Wheelbarrow Compressors:

1. Subject to the exceptions, exclusions and limitations described below, SENCO warrants that the compressor pump will be free from defects in materials and workmanship for two years after the purchase date.
2. Defective parts of the compressor pump not subject to normal wear and tear will be repaired or replaced, at SENCO's option, during the two year warranty period. If SENCO determines that repair or replacement is not feasible, SENCO will refund the purchase price less reasonable depreciation based on actual use.

SENCO Cordless:

1. Subject to the exceptions, exclusions and limitations described below, SENCO warrants that the SENCO Cordless tool will be free from defects in materials and workmanship for two years after the purchase date.
2. SENCO warrants that the batteries and chargers used with SENCO Cordless tools will be free from defects in material and workmanship for one year after the purchase date.

WARRANTY EXCLUSIONS

The following warranty exclusions apply:

1. Normal wear parts are not covered under this warranty. Normal wear parts include, for example, isolators, drive belts, air filters, rubber o-rings, seals, driver blades, piston stops, and piston/driver assembly.
2. This warranty does not cover parts damaged due to normal wear, misapplication, misuse, accidents, operation at other than recommended speeds or voltage (electric units only), improper storage, or damage resulting during shipping.
3. Products used in production/industrial applications as defined by SENCO are excluded from this warranty.
4. Labor charges or loss or damage resulting from improper operation, maintenance or repairs are not covered by this warranty.
5. SENCO does not warrant the Wheelbarrow Compressor Engine/Motor, but the Compressor Engine/Motor may be covered under a warranty offered by its manufacturer.

GENERAL WARRANTY CONDITIONS

This warranty will be honored, only if:

- A. Clean, dry, regulated compressed air has been used, at air pressure not exceeding the maximum indicated on the tool casting;
- B. No evidence of abuse, abnormal conditions, accidents, neglect, misuse or improper modifications or storage of the product; and
- C. No Deviation from operating instructions, specifications, and maintenance schedules exists (read Operator Manual for use, specifications, and maintenance instructions).

THIS WARRANTY IS THE ONLY WARRANTY ON THE PRODUCT, AND SENCO DISCLAIMS ALL OTHER WARRANTIES. ANY IMPLIED WARRANTIES WILL BE LIMITED IN DURATION TO THE APPLICABLE WARRANTY PERIOD SPECIFIED ABOVE. SOME STATES DO NOT ALLOW LIMITATIONS ON HOW LONG AN IMPLIED WARRANTY LASTS, SO THE ABOVE LIMITATION MAY NOT APPLY TO YOU. YOUR REMEDIES ARE SOLELY AND EXCLUSIVELY AS STATED ABOVE. SENCO SHALL IN NO EVENT BE LIABLE FOR INCIDENTAL, CONSEQUENTIAL, INDIRECT, OR SPECIAL DAMAGES. SOME STATES DO NOT ALLOW THE EXCLUSION OR LIMITATION OF INCIDENTAL OR CONSEQUENTIAL DAMAGES, SO THE ABOVE LIMITATION OR EXCLUSION MAY NOT APPLY TO YOU. IN NO EVENT, WHETHER AS A RESULT OF A BREACH OF CONTRACT, WARRANTY, TORT (INCLUDING NEGLIGENCE) OR OTHERWISE, SHALL SENCO'S LIABILITY EXCEED THE PRICE OF THE PRODUCT WHICH HAS GIVEN RISE TO THE CLAIM OR LIABILITY. ANY LIABILITY CONNECTED WITH THE USE OF THIS PRODUCT SHALL TERMINATE UPON THE EXPIRATION OF THE WARRANTY PERIOD SPECIFIED ABOVE. NO EMPLOYEE OR REPRESENTATIVE OF SENCO OR ANY DISTRIBUTOR OR DEALER IS AUTHORIZED TO MAKE ANY CHANGE OR MODIFICATION TO THIS WARRANTY.

This warranty gives you specific legal rights, and you may also have other rights which vary from state to state.

REPLACEMENT OF TOOL DUE TO NATURAL DISASTER

SENCO will replace any tool destroyed by an Act of God such as flood, earthquake, hurricane or other disaster resulting only from the forces of nature. Such a claim will be honored provided that such original retail purchaser had previously submitted a completed warranty registration card for the tool, and then submits proof of ownership and an acceptable statement describing such Act of God documented by an insurance carrier, police department, or other official governmental source. To obtain instructions for filing a claim call 1-800-543-4596.

CUSTOMER SATISFACTION

One hundred percent customer satisfaction is our #1 goal. If for any reason the product does not perform to the original purchaser's satisfaction, it can be returned to the place of purchase **within thirty days** with dated sales receipt for a full refund of the purchase price.