

# ScreenRail

## Installation Instructions

- These instructions must be followed exactly as written and the materials used must be exactly as shown in the instructions. Any deviation from the instructions or variation in the materials used/installed may result in an unsuccessful installation.
- Tools Recommended: Hammer, Tape Measure, Miter Saw (with aluminum cutting blade), Screw Gun (with #2 square drive bit), Drill (with 3/16" bit), Level, Non-scuffing Mallet or Wood Block.

### POST AND FRAME RAILS

ScreenRail Post and Frame Rails consist of: Post, Post Mount with Screws, Rail with Cover, Rail Mount with Cover and Screws. (Illustrations P1 and P2.)

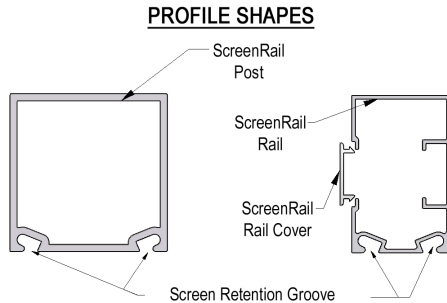

Illustration P1

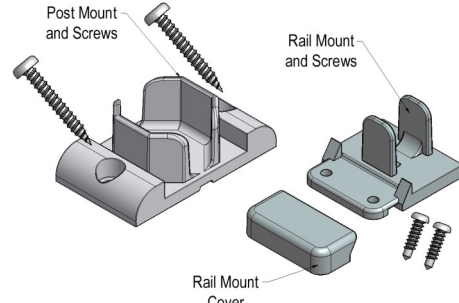

Illustration P2

**Step 1:** Determine spacing of vertical posts to match the widths desired for installing screen you will use. An equal (or near equal) spacing of posts will give your room a more esthetically pleasing appearance. Narrower widths of screen are easier to install and are affected less by wind than wide screen widths. (NOTE: Between post spacing should be 6" less than screen width.)

**Step 2:** Screen retention grooves (Illustration P1) are needed at all vertical and horizontal perimeters that are to be screened in. Screen retention grooves must always be on the side the screen is to be attached. (NOTE: Install all vertical posts and rails prior to installing horizontal rails.)

**Step 3:** Measure height for posts. Cut post 1/2" shorter to allow for a post mount at each end.

**Step 4:** Attach post mounts (Illustration P3) with #14 x 1-3/4" screws (provided) or appropriate fastener for the surface to be attached to. (Concrete anchors, Tapcons, etc.) NOTE: Screw hole has to be on side of post with screen retention grooves.

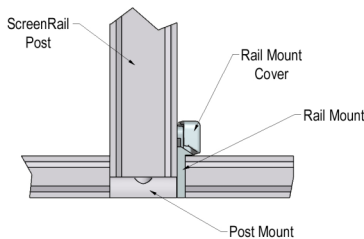

Illustration P3

**Step 5:** Cut rail to desired length. (Illustration P4.) Attach rails with appropriate stainless steel fasteners 16" on center.

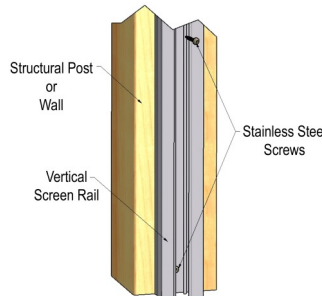

Illustration P4

**Step 6:** Cut rail covers to the same length as the rail. (Hint: Slide one side of the cover into the retaining slot and snap cover on by starting at one end and working toward the other end. Snap cover onto rail.) (Illustration P5.)

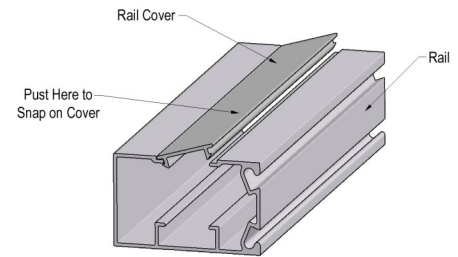

Illustration P5

**Step 7:** Cut horizontal to desired length. (Illustration 6.)

**Option A: Surface Mount Rails**

Cut the rail to the exact length between vertical rails or posts positioned in previous steps. Attach rails with appropriate stainless steel fasteners 16" on center.

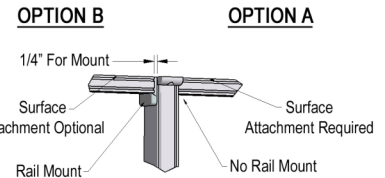

Illustration P6

**Option B: Rail Mounts**

Cut the rail 1/4" shorter per mount (total 1/2" for 2 mounts) than the distance measured between the vertical rails or posts. Attach rails with appropriate stainless steel fasteners 16" on center.

**Step 8:** Cut screen rail covers to the exact length of the rails and snap them onto the rail. Where mounts are used, cut the cover retainer hooks off. (Illustration P7.)

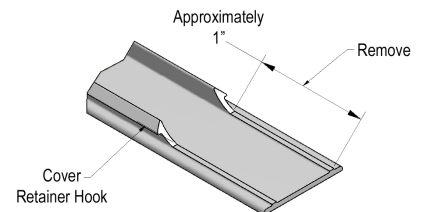

Illustration P7