

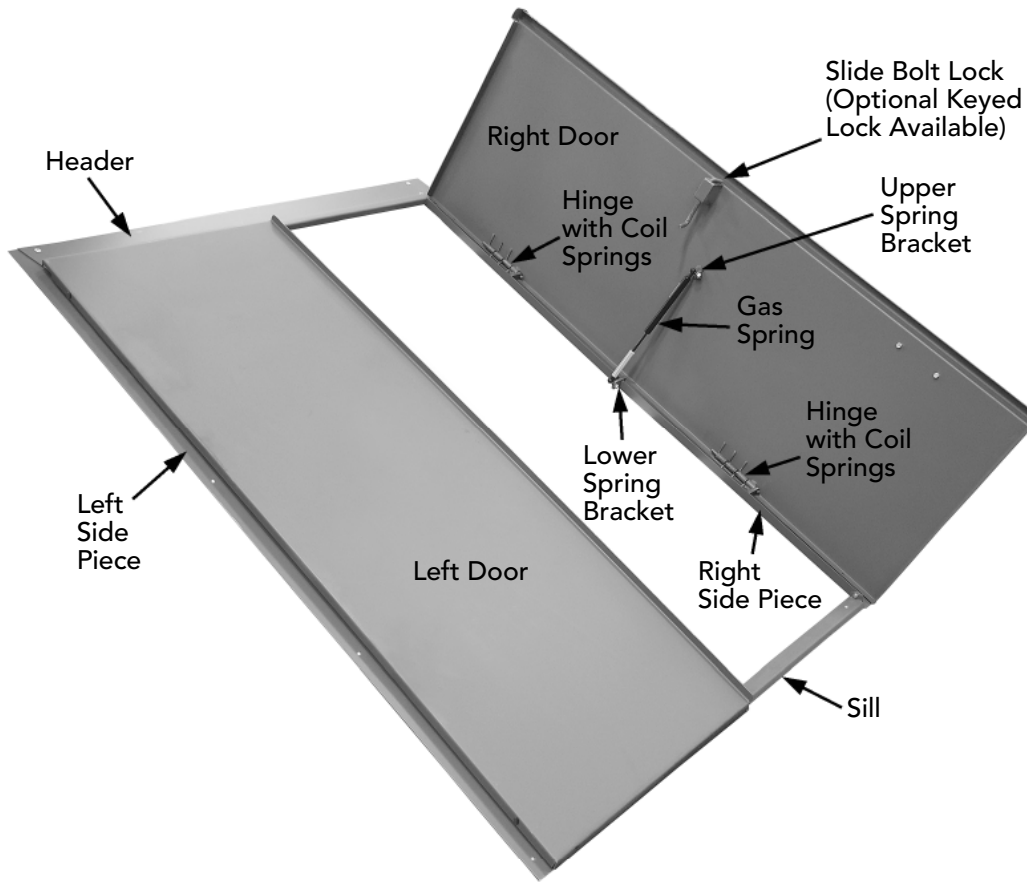

Experience. Innovation.

BILCO Type BR Sloped Wall Basement Door Installation Instructions

Log-on to www.bilco.com/install for answers to frequently asked installation questions.



The BILCO Sloped Wall Basement Door must be installed square and level on a structurally sound foundation.

The BILCO Door is designed to operate with ease, keep your stairs dry and free of debris, and deliver many years of trouble free service when installed in accordance with these instructions. Some installations may require that you drill and cut metal. Be sure to use the proper tools, wear proper safety equipment and clothing, and secure any item to be drilled or cut to a stable work surface.

Package Contents:

Please verify that you have received all door components before starting your installation.

- (1) Right Side Piece
- (1) Left Side Piece
- (1) Right Door Panel
- (1) Left Door Panel
- (1) Hardware box
 - (1) Sill panel
 - (1) Header panel
 - (1) Flashing Strip
 - Coil springs (BR1=6, BR2=8, BR3=12)
 - (2) Gas springs
 - (4) Ball stud fasteners
 - (1) Door Handle kit
 - Hardware Kit*

* See detailed list on next page

Depending on the installation, the following tools and material may be required:

- | | |
|-------------------------|------------------------------------|
| Hammer and Nails | Pry Bar |
| Sledge Hammer | Level |
| Masonry Chisel | Tape Measure |
| Circular Saw | Abrasive Metal Cutting Blade |
| Jig Saw | Metal Cutting Jig Saw Blade |
| Electric Drill | 1/4" + 9/32" High Speed Drill Bits |
| 7/16", 9/16" Wrenches | 1/4" Carbide Masonry Drill Bit |
| Flat blade Screwdriver | Hack Saw |
| Work Gloves | Shovel and Trowel |
| Eye Protection | Mortar Tub |
| (1) Tube Silicone Caulk | Hearing Protection |

CAUTION

When the doors are open for access, the area should be personally guarded to prevent anyone from falling down the stairs. Doors should be closed and locked when not in use.

KEEP OFF DOORS TO AVOID INJURY

Surface may be slippery. In extreme conditions steel in the summer sun can become hot and cause injury.

Foundation Requirements

CAUTION: The BILCO Basement Door sheds water in all normal conditions only when installed and caulked in accordance with these instructions. If there are no rain gutters above, a diverter must be installed to prevent roof water from flowing directly onto the BILCO Door.

Sloped sidewalls must be structurally sound and level for proper operation of your new BILCO Door. Remove the old door and check sidewalls. If no repairs are required, begin your installation with Step - 1.

Foundation Wall Requirements

- Solid construction with no loose or crumbling masonry
- Uniform flat and level surface to anchor the door
- Side walls must be uniformly level with each other
- The door sill must be allowed to sit 2" to 4" above grade

How to Repair Masonry Sidewalls

If repairs are needed, they should be done before the BILCO Door is installed. Some basic guidelines are provided below, but a masonry contractor may be required for extensive areaway damage.

1) Mortar Joints Loose or Crumbling: Remove loose material and crumbling mortar to solid masonry, or a depth of one inch, whichever is greater. Clean all surfaces with water. Refill joints with pre-mixed, bagged mortar cement, following instructions on mortar bag. See your masonry supply dealer for complete information.

2) Sidewalls Need Reinforcing and Resurfacing: Apply fiberglass surface bonding cement to both sides of the walls to reinforce, resurface and waterproof them. Several brands are available from your masonry supply dealer. Surface preparation and application methods are critical. Follow manufacturer's instructions for the brand you use.

3) Top Surface of Sidewalls is Rough, Not Level: Prepare surface for new concrete cap by removing all loose material down to solid masonry, rough up surface and clean with water. Apply masonry bonding agent and pour new concrete cap using bagged, pre-mixed concrete mix. Check with your masonry supply dealer for best bonding agent and concrete mix. Form a level surface on top of each sidewall and be sure both walls are level with each other. Pressure treated wood may be used instead of concrete. It must be level, caulked and firmly anchored to the foundation. You may wish to use

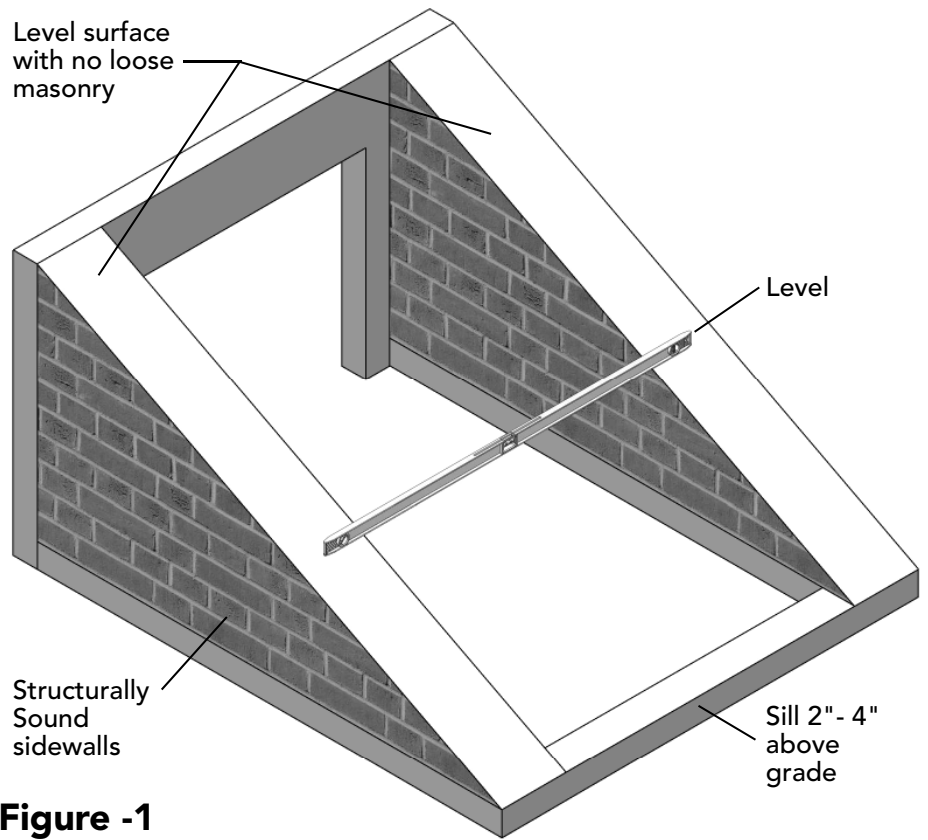

Figure -1

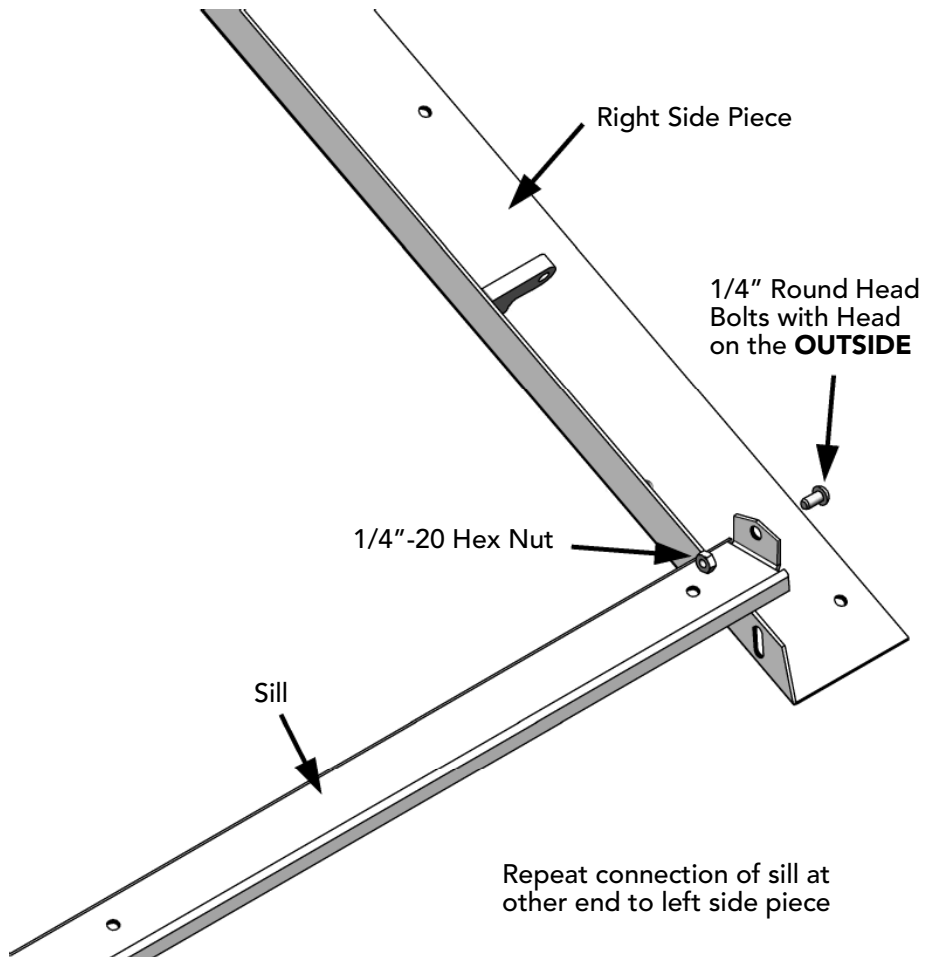

Figure -2

BILCO Foundation Plates, available from your BILCO Dealer, to finish the top of the sidewalls. See page 6 or visit www.bilco.com for more information.

4) Single Course Brick Sidewalls: Brick sidewalls that are only one brick wide may not be strong enough to support the BILCO Door. They should be reinforced with another course of brick, or by a concrete wall poured against the brick wall and tied into it with wall ties.

STEP - 1 Assemble Door Frame

The BILCO Type BR basement door consists of seven parts (see front cover for part names), two gas springs, and the hardware package*.

Begin assembly of the door frame by attaching sill to side pieces with two 1/4" round head bolts with bolt heads on the outside per Figure - 2. Hand tighten sill bolts.

* Hardware

- (8) 5/16" x 1" cotter pins
- (2) 1/4"-20 x 1/2" round head bolts
- (2) 1/4"-20 hex nuts
- (21) 1/4" x 2" nail-in anchors

STEP - 2 Position Door Frame on Foundation

Be sure masonry foundation is in good condition and level, clean and dry. Door sidepieces must be fully supported on each side. BILCO Foundation Plates are available for rough or uneven areaway surfaces (see last page of instructions or www.bilco.com for more information).

Move assembled door frame into place on foundation. Position header panel on top of side pieces as shown in Figure 3. For proper door operation, **the frame must be level and square**. To square, see Figure - 3 and measure diagonals from top right inside corner to bottom left inside corner and from top left inside corner to bottom right inside corner. Move lower end of frame to left or right until diagonal measurements are equal. Adjust sill by pivoting until flush with foundation and tighten bolts.

STEP - 3 Anchor Door Frame to Foundation

The door frame must be securely anchored to a sound masonry foundation,

Drill anchor holes using holes in sill, header and side pieces as a guide

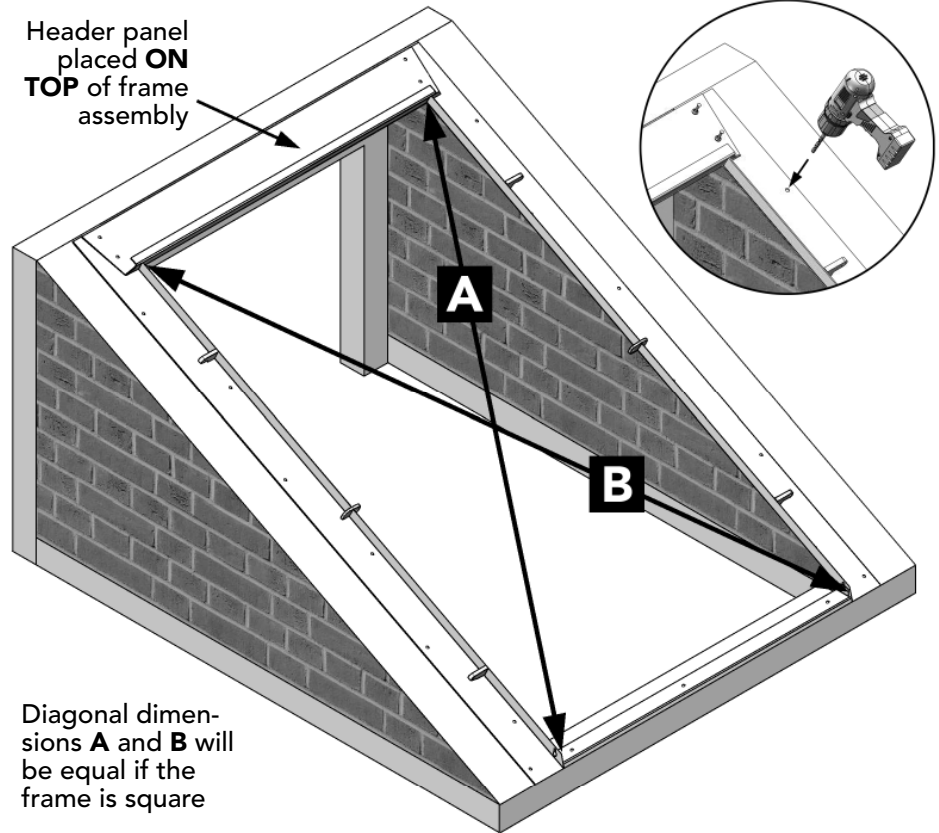

Figure - 3

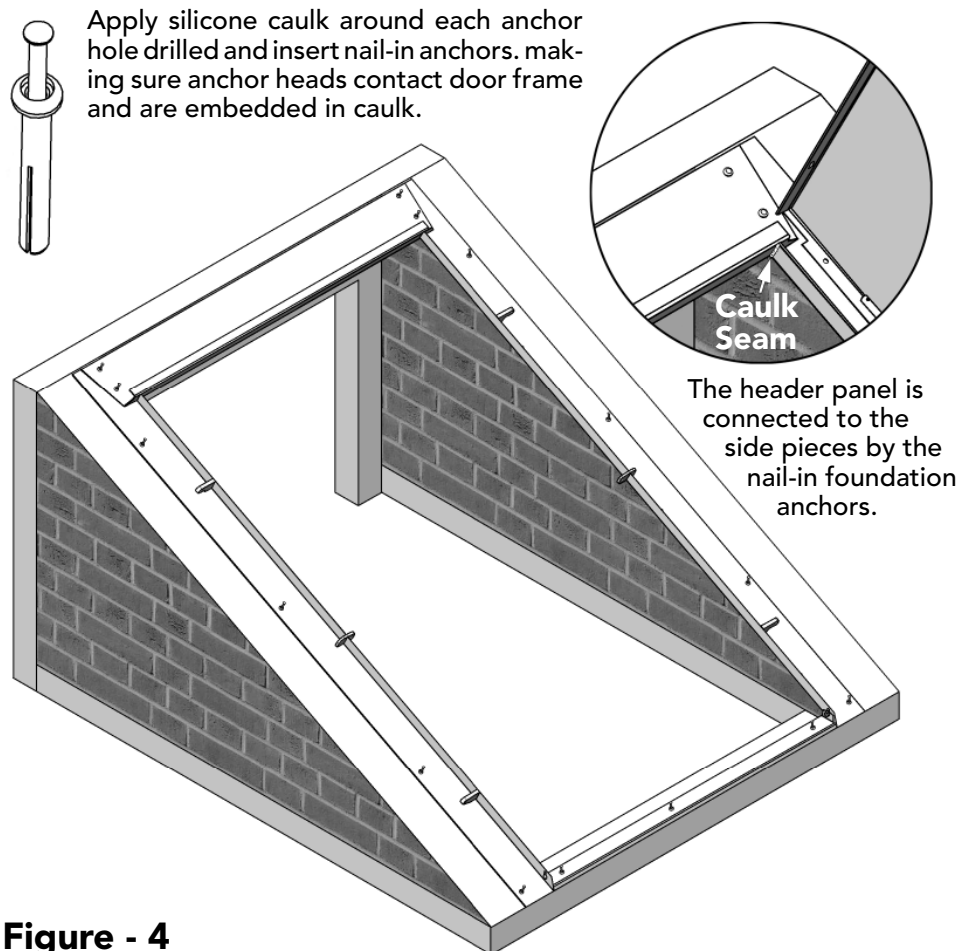

Figure - 4

or to foundation plates that are firmly anchored to the foundation. **No part of the BILCO Door should be covered with concrete.** Apply bead of silicone caulking compound (not supplied) to clean, dry masonry foundation underneath door frame. Verify that door frame is level and square as shown in Figure 1.

Using pre drilled holes in sidepieces, header, and sill as a guide, mark and drill holes into the foundation 2-1/4" deep using a 1/4" carbide tipped masonry bit as shown in Figure 4. Apply silicone caulk around each anchor hole and insert nail-in anchors, making sure anchor heads contact door frame and are embedded in caulk. Hammer down anchors until flush and secure.

Once the frame is fully anchored to the areaway, caulk the seams between the header and the side panels as shown in Figure 4.

STEP - 4 Install Doors

Caution: Door leaves are heavy and will slam closed until gas spring lift assistance is installed in Step 5. Use caution until gas springs are fully operational.

Position right hand door leaf so that hinge pins align just above hinge brackets on side panels as shown in Figure 5. Slide door downward so the hinge pins fully engage into brackets and secure using a cotter pin as shown in Figure 5. Repeat for left hand door leaf.

STEP - 5 Install Lift Assistance

Starting on either door leaf, attach ball stud fasteners to lower spring bracket and upper spring bracket as shown in Figure 6. Note: Make sure the that ball portion of the fastener is facing away from the house on both brackets. With fasteners securely tightened and door in the open position, push gas spring onto lower ball fastener as shown in Figure 6 until you hear it snap into place. Position and snap top end of gas spring onto upper spring bracket. **IMPORTANT:** The exposed spring portion of the gas spring must be on the bottom as shown. Repeat process on other door leaf.

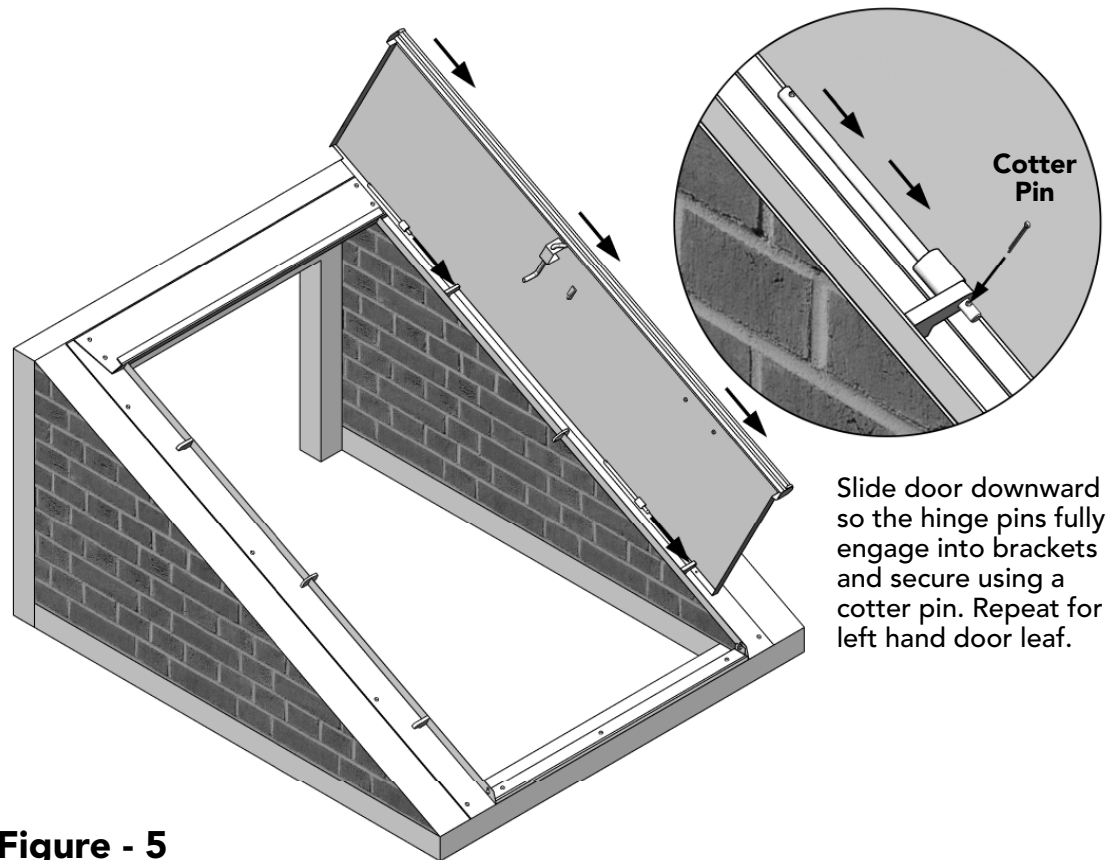

Figure - 5

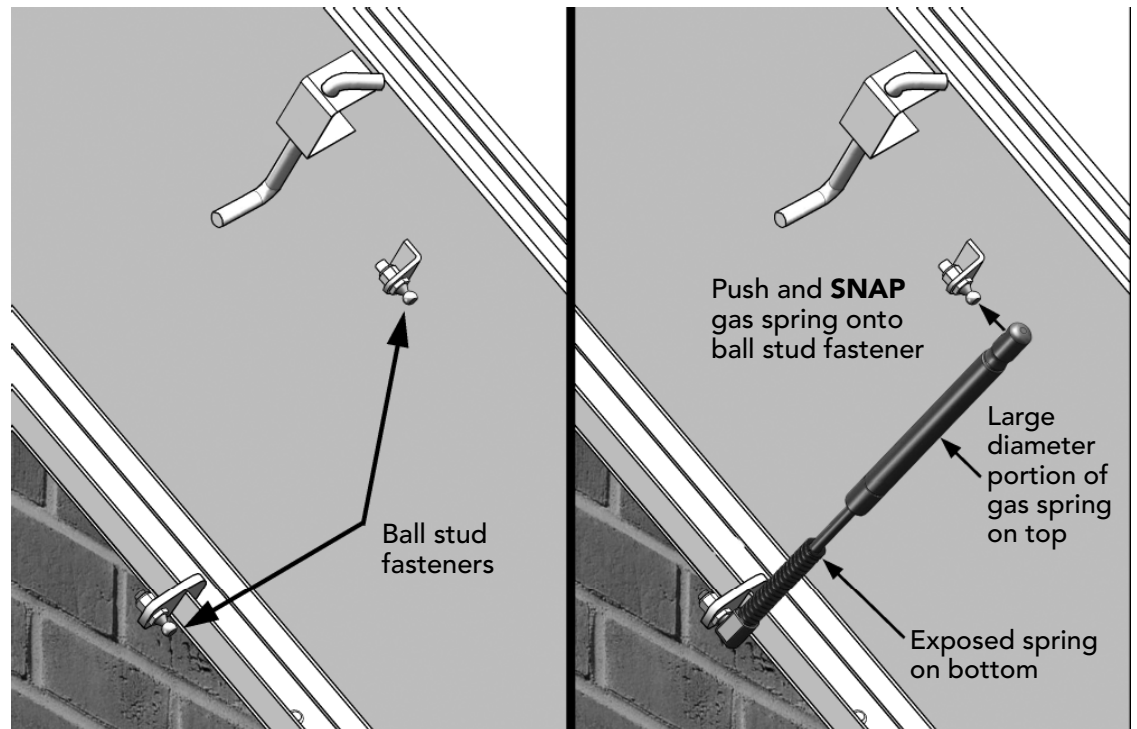

Figure - 6

The BILCO Type BR door is designed with supplemental coils springs that allow you to fine tune the door's lift assistance

based on the angle of installation. The springs are installed by simply sliding them onto the hinge pins as shown in Figure 7. Multiple springs can be used on each hinge and you can adjust the quantity until the door operates to your liking. Secure coil springs to hinge pins using cotter pins as shown.

STEP - 6 Lift Handle Installation

Attach lift handle to right hand door leaf using fasteners and separate instruction sheet provided with door hardware.

STEP - 7 Painting Instructions

BILCO Basement doors are supplied in either a red oxide primer or powder coat paint finish. If your door has a powder coat finish, no additional finishing is required.

IMPORTANT: Doors supplied with a primer finish must be painted within forty-five (45) days of installation. BILCO requires the use of an **exterior alkyd base enamel**. For best results, carefully follow the directions on the paint label and apply one thin coat of paint followed by a second coat on both the exterior and interior primed steel surfaces of the door. Two quarts should be sufficient to coat the entire door. **Application of paints that are not alkyd based may void product warranty.**

STEP - 8 Flashing installation

Position aluminum flashing strip so that it rests on top of header panel and against house as shown in Figure 8. Anchor flashing strip to house using the appropriate fasteners for the wall construction as shown. (Note: these fasteners are not included in the hardware package).

When anchoring is complete, replace siding as required so that it covers the top edge of the flashing strip.

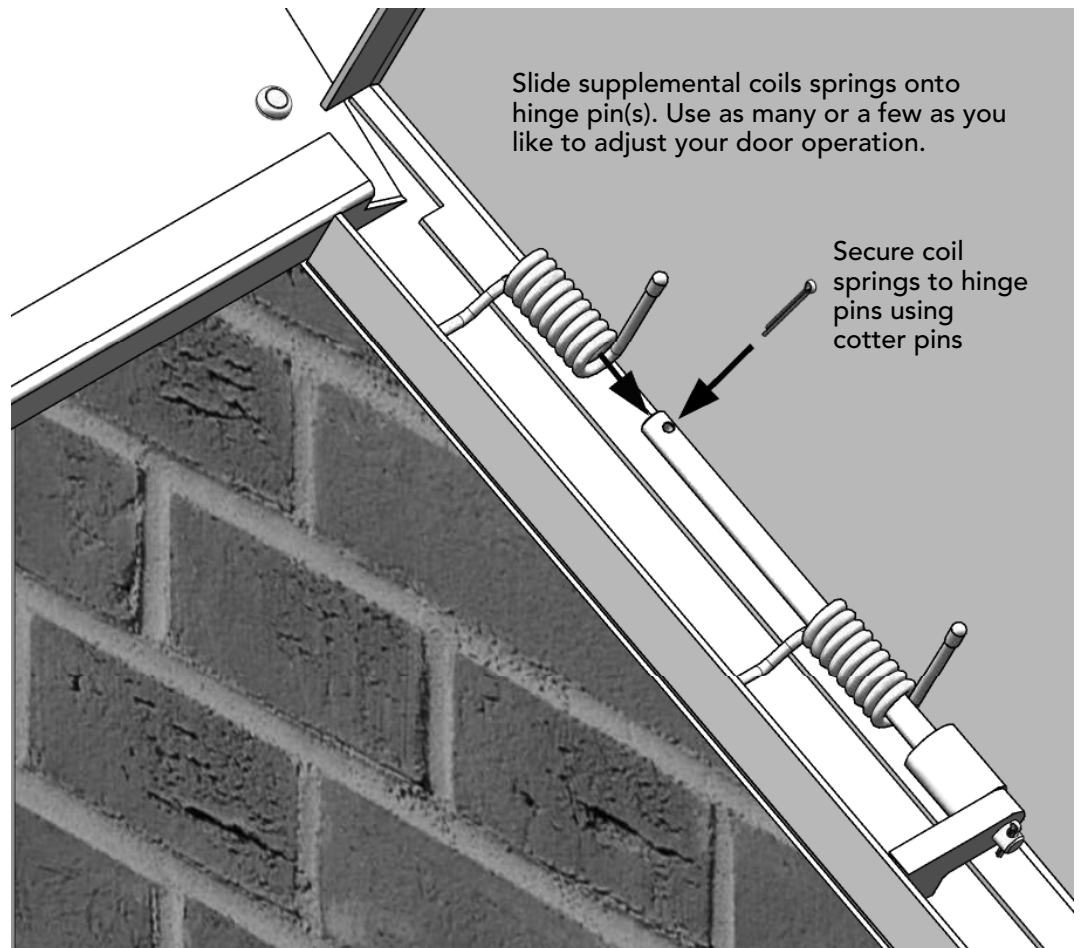

Figure - 7

Position aluminum flashing strip on top of header panel and secure to exterior wall using appropriate fasteners.

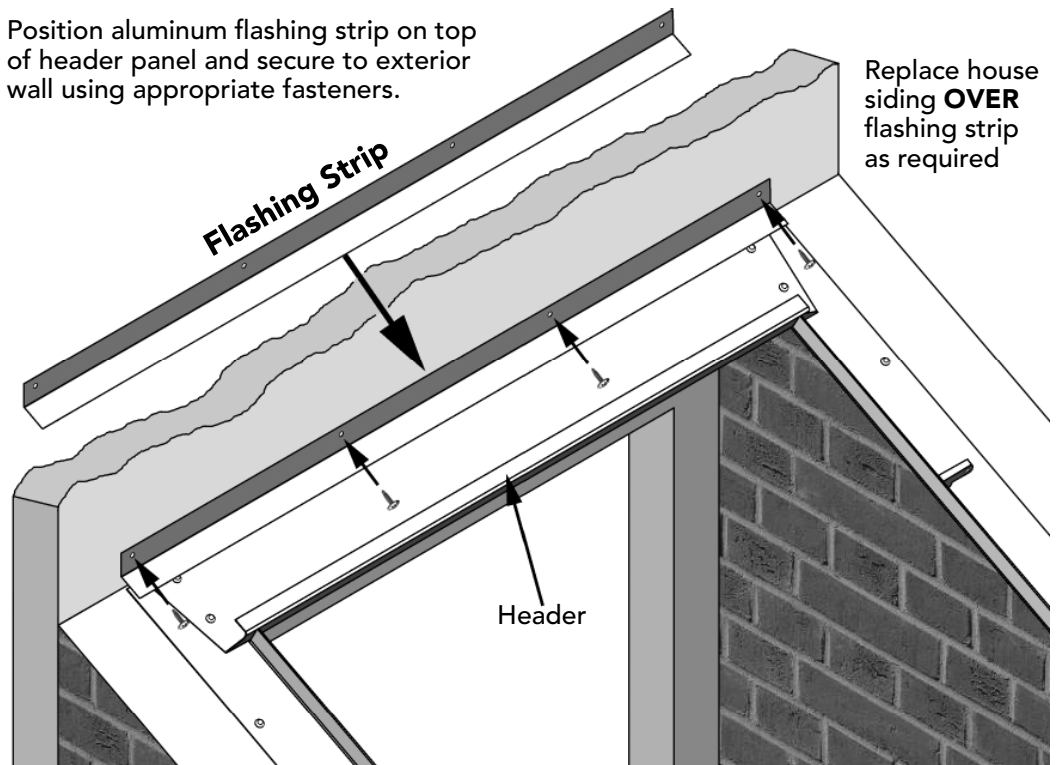

Figure - 8

IMPORTANT: For masonry home applications, run a full bead of caulk along the top edge of the flashing strip to ensure a watertight installation. (Do not caulk using mortar).

How to correct installation errors or repair minor damage

Door not shedding water. If your BILCO basement door does not shed water, look for and correct these installation errors.

1. Header panel not caulked. The vertical seam between the header panel and side panels must be fully caulked on both sides to ensure a weathertight assembly (see Step 3, Figure - 4).
2. Doors do not fully close. Stand on steps and slowly close each door to see if the bottom flange of one or both is binding on the concrete. Chip away or rub down excess concrete with mason's stone so flange is not obstructed.
3. Sill not high enough. The masonry under the BILCO basement door should be 4" higher than the surrounding grade and concrete should be level so water cannot accumulate in front of the sill.
4. Water seeping between steel and masonry. The unit should be caulked all around the exterior where the steel and masonry meet, as well as where the unit joins the building wall. If side pieces have been buried in concrete, the unit should be removed and sidewalls recapped so assembly rests on top.
5. Blocked header channel. Make certain channel is clear of leaves, dirt, and debris. Any blockage in this channel will cause water to overflow the header.

Basement Door Accessories



Keyed Lock Kit

Enjoy the convenience of locking and unlocking your Classic Series BILCO basement door from the outside with a basement door keyed lock kit. Install a BILCO keyed entry lock and save the trip into the basement to lock or unlock the door.



Foundation Plates

Foundation plates can be used to improve an areaway's appearance, cover rough masonry, reduce the inside areaway width, or for side support in corner installations. Formed plates are prime-painted steel and are now available with a factory applied powder coat paint finish.



Weather Strip Kit

BILCO'S basement door weather strip kit is designed to reduce gaps, and to block leaves, dirt, and pests from your basement area way. The easy to install kit is supplied with installation instructions.



Stair Stringers for Basement Areaway

Stair stringer sizes are available for all BILCO Basement Doors sizes. Constructed of heavy galvanized steel, BILCO stair stringers for basement areaways are an economical and more durable alternative to wood stair stringers for your basement areaway.



BILCO Customer Service: (800) 854-9724 | Weekdays 9 AM to 5 PM EST
residential@BILCO.com | www.BILCO.com